

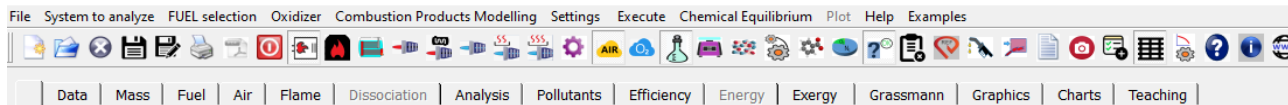

THERMOCOMBUSTION | Technical & Educational Software

Software developed for combustion processes' characterization. Major application to industrial combustion processes, such as combustion heat or electricity generation processes; whether they take place in steam generators, gas turbines or stationary engines, and in industrial furnaces (with or without fire contact).



INDEX

Characteristics

- **Solid technology**
- **Precision**
- **Easy handling**
- **Intuitive interface**
- **Input variability**
- **Application in several industrial systems**

Software capabilities

- Thermo-chemical analysis
- Mass, energy and exergetic balance
- Energetic flow and *Grassmann* diagram
- Thermal and exergetic efficiency
- Combustion diagrams
- Sensitivity analysis
- Pollutant emissions control

Applications

Improvement of combustion process design, comprehensive study of main variables effect in the combustion, whether reducing irreversibilities or pollutant emissions; or performing several sensitivity analysis that *Thermocombustion* facilitates by default.

Main application in industry for process optimization or in academia (technical studios).

Characteristics

Software algorithms are based on up-to-date bibliography and the latest mathematical models, which in conjunction result in a **well-defined** and **solid technology**. The software has been set up with an **intuitive interface** that allows **easy handling**.

Input variability

The user can choose the **composition**: mixture of hydrocarbons, aviation fuel, by empirical formula, etc.

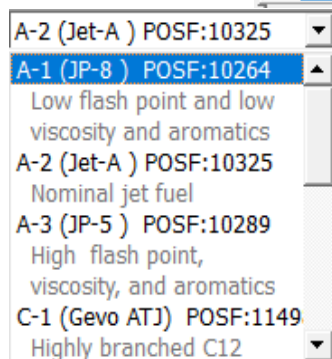
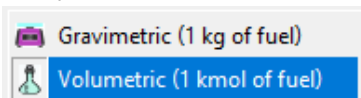

Fuel selection features, Jet-fuel

Application in several industrial systems

Combustion chamber, industrial furnace, steam boiler or combustion turbine (internal or external).

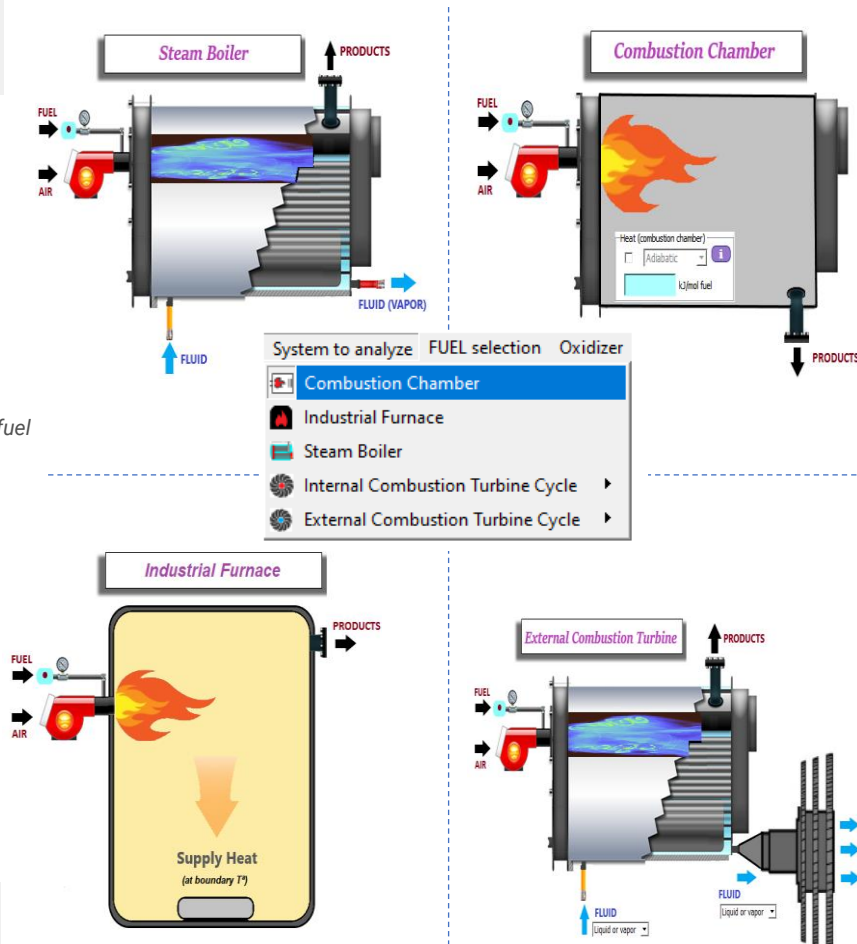

Industrial combustion systems available to analyse

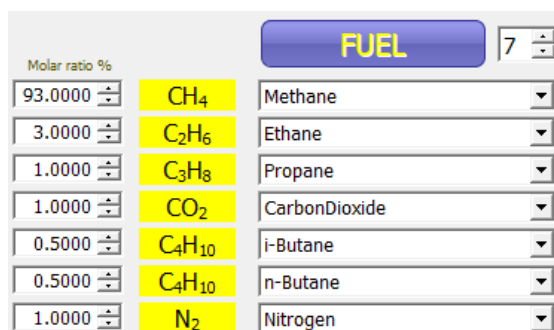

Fuel selection features, Natural gas

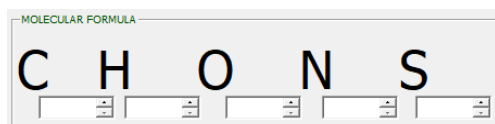

Fuel selection features, Molecular formula

Gas turbine cycles can be studied. There are essentially two types of gas turbine cycles. The simple cycle, where the gas is exhausted directly to atmosphere. The regenerative cycle, where the exhaust gas is used in an exchanger (regenerator) to preheat the compressor discharge air prior to the combustor.

Internal Combustion Turbine

COMPRESSOR
Isoentropic efficiency %
Cooling temperature (compressor inlet) °C
 Spray cooling
Humidification °C

Regenerative cycle
Gas turbines intercooled by water spray injection systems have recently entered service. ThermoCombustion permits to study this effect to be evaluated and compared with conventional cooling techniques for a range of cycles.

Internal Combustion Turbine Cycle
Basis Cycle (no regenerative)
 Regenerative Cycle

Regenerative Heat Exchanger
Pressure in the exhaust TG kPa
Temperature in the exhaust TG °C
To the Ambient °C
From the Compressor °C
To the Combustion Chamber
Effectiveness %
Pressure loss kPa %
 Hot-Side
 Cold-Side
 Convexional Regenerative
About

External Combustion Turbine Cycle

Steam turbines are external combustion. They don't have a compressor like a gas turbine has, instead, water is boiled in a separate boiler (external to the turbine) and then fed to the turbine where it pushes against the turbine blades and spins them.

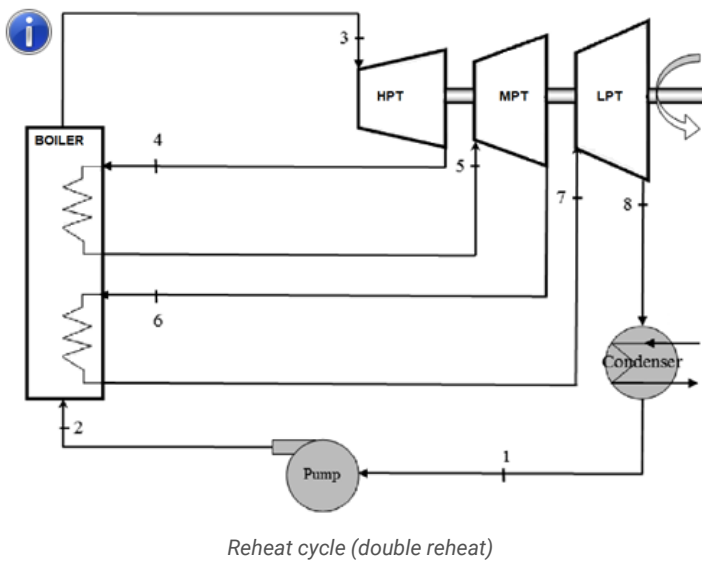

External Combustion Turbine Cycle
Basis Cycle (no reheat)
Single Reheat (two-stages) Cycle
 Double Reheat (three-stages) Cycle

Reheat cycle
Double reheat
Pressure kPa
Temperature °C
About
Pressure kPa
Temperature °C

Teaching activity (Not available in industrial version)

The teacher can design a teaching activity that the student will solve using the software and the score obtained by the student, results and student responses are generated immediately in a pdf file no-editable.

This activity is very attractive for the learning-teaching process in technical studies, both for the teacher and for the student, since it allows to solve the exercises and/or design projects in an efficient and fast way, and the knowledge of the qualification obtained by the student is immediate.

Configuration (teaching mode)

- Mass
- Fuel
- Air
- Flammability
- Flame
- Dissociation
- DewPoint
- Analysis
- Pollutants
- Efficiency
- Energy
- Exergy
- Grassmann/Sankey
- Graphics
- Charts

Add a figure
 Add solutions
 Add exercise statement to pdf results

Results name file: ID number/NIF

Letter size: 10

Save
Save As
Open problem
OK

Name (teacher): Joaquin Zueco Jordán

Duration: 50 Min Notice (near the end): 2 Min

Variable number (exercise statement) System: Combustion Chamber
Choose (oxidizer)

Variable: Choose (FUEL:)
 Choose (Mole/Mass) Choose (for fuel)

Decimals From problem 0 1

Random From: 1,00 To: 10,00

Bold (variables)

Punctuations (answers) 10 (MAX)
Choose points Solution (opt)

Choose No dissociation Allowable margin of error 10 %

Combustion charts

Ostwald, Grebbel, Bunte and **Kissel** combustion diagrams allow fast and accurate combustion calculations. In order to get an analysis closer to reality, it is possible to work in 'dissociation' mode; it facilitates the combination of the most common chemical reactions in this processes. Combustion processes are characterized by the presence of unburned, these substances are generally carbon such as soot, CO, H₂ and small amounts of hydrocarbons used as fuels may also appear.

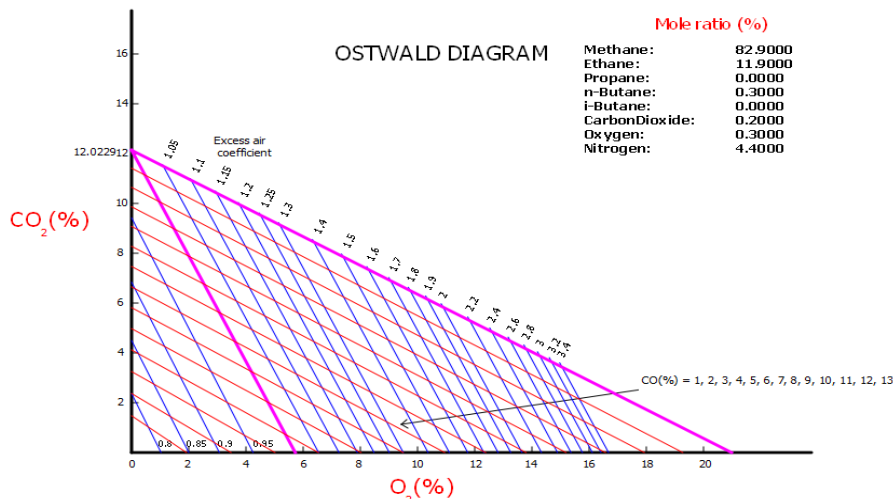

In the case of the combustion reaction in which only CO is produced in the combustion gases, it is known It is a graphical representation of a combustion process, for a specific fuel. Once the diagram for that fuel has been developed, through a smoke analysis, knowing the percentage of one of the three elements represented (%CO₂, %CO or %O₂) and knowing the excess air, we can know the composition of the rest of the exhaust gases.

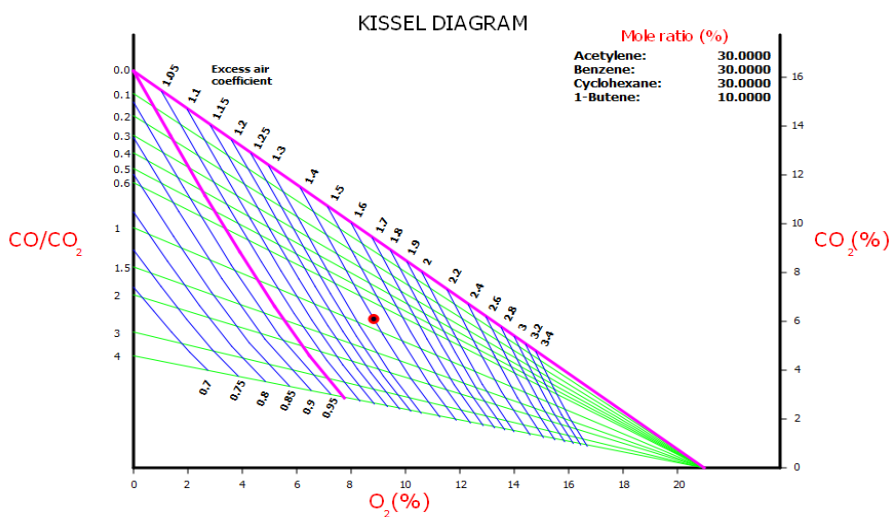

In the case of the combustion reaction in produces CO and H₂ is known as Kissel Combustion. These denominations derive from the use of the diagrams of these authors used to determine the respective combustion reactions, being evident that the Ostwald reaction is a particular case of the Kissel reaction.

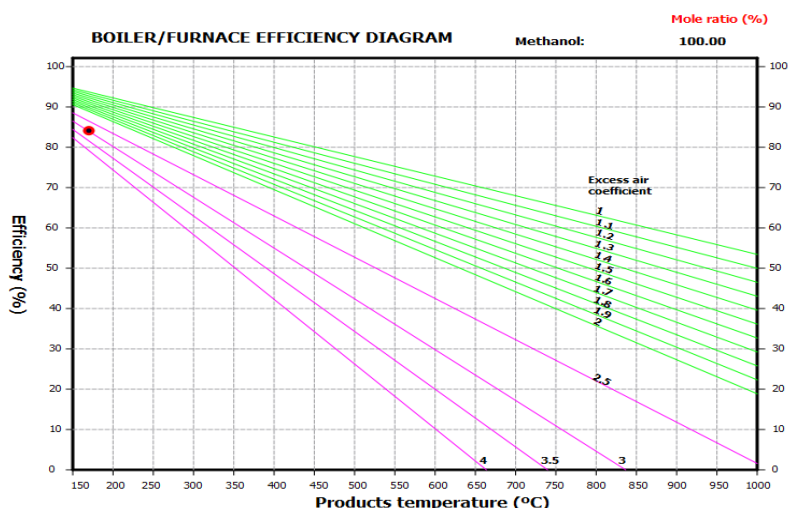

The performance will increase as the smoke temperature decreases, and the percentage of CO₂ in the combustion products increases. But the increase in CO₂ can lead to an uncontrolled increase in dangerous CO with problems for the boiler home and especially for the safety of people.

Thermo-chemical analysis

As a first step, a **mass balance** of combustion products can be obtained. Strict analysis on whole range of **fuel properties**: calorific powers, specific heat, enthalpy of formation, chemical exergy, entropy, including the flammability diagram.

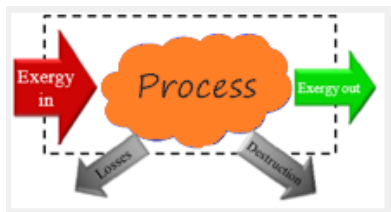

Exergy analysis

From second law evaluations (entropy or exergy evaluations) it is generally known that thermodynamic losses of boilers and furnaces are much higher than the thermal efficiencies do suggest.

| | <input type="checkbox"/> mol/kg fuel | <input type="checkbox"/> kg/kg fuel | <input checked="" type="checkbox"/> Mole % | <input type="checkbox"/> Mass % |
|------------------|--------------------------------------|-------------------------------------|--|---------------------------------|
| CO ₂ | 1.0766549 | 2.5656038 | 6.7279286 | 10.5443677 |
| CO | 0.0043451 | 0.0065898 | 0.0271522 | 0.0270834 |
| H ₂ O | 2.0281479 | 1.9783577 | 12.6737309 | 8.13085 |
| N ₂ | 11.8112316 | 17.9153883 | 73.8074221 | 73.6304040 |
| O ₂ | 1.0165737 | 1.7613777 | 6.3524859 | 7.2390813 |
| H ₂ | 0.0018519 | 0.0002021 | 0.0115724 | 0.0008306 |
| NO | 0.0638865 | 0.1037987 | 0.3992215 | 0.4266020 |
| NO ₂ | 0.0000776 | 0.0001932 | 0.0004849 | 0.0007940 |
| TOTAL | 16.0027695 | 24.3315086 | 100.000 % | 100.000 % |

Mass balance interface

Sensitivity analysis

Analysis of main variables involved in the combustion processes' study. Graphical display of main results, energy balance, mass balance, pollutants, temperatures, efficiencies, exergy balance, etc.

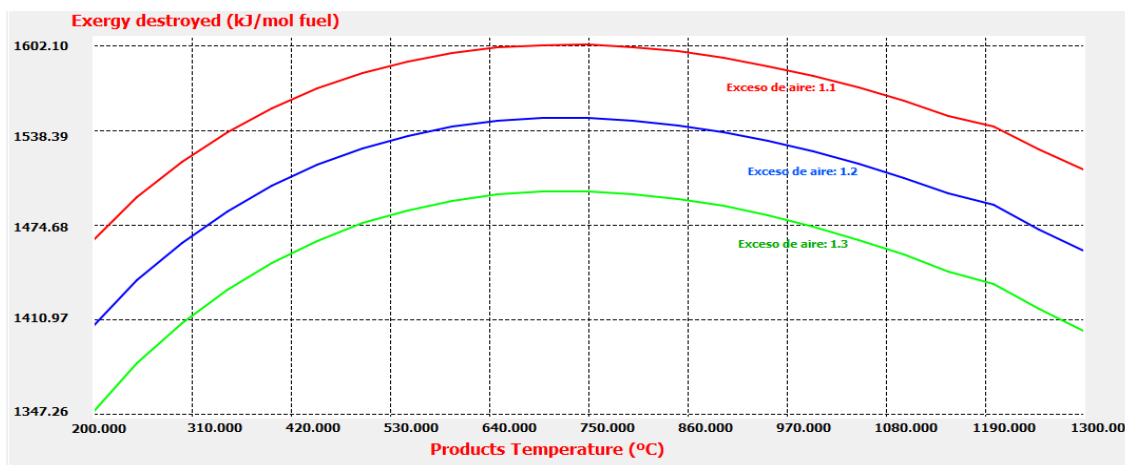
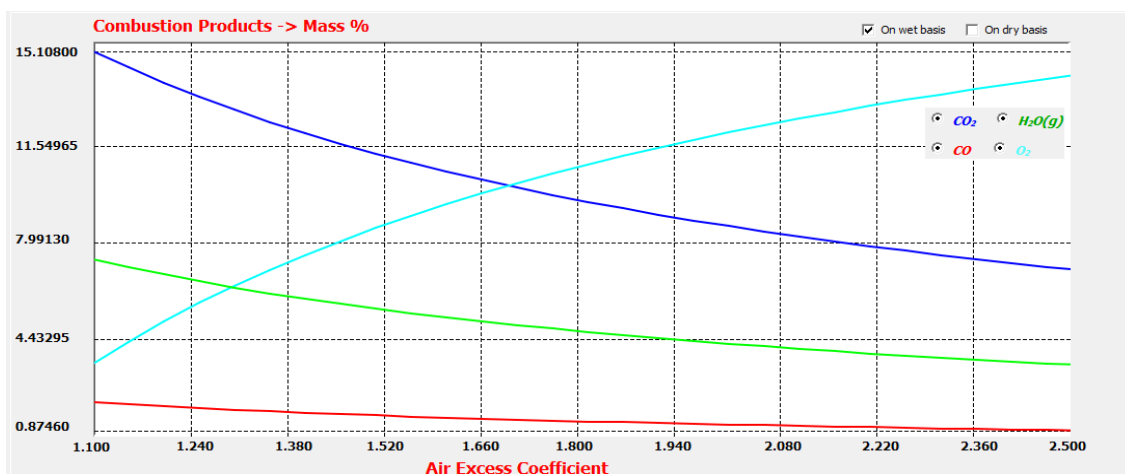
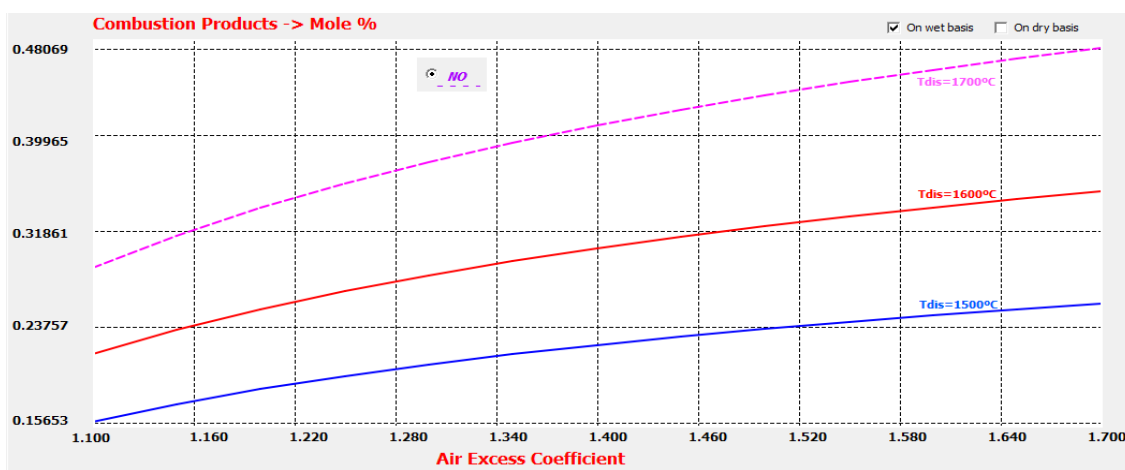

Graphic representations of sensitivity analysis



Energetic analysis

Includes flow diagram with **energetic efficiency** obtained by different methods.

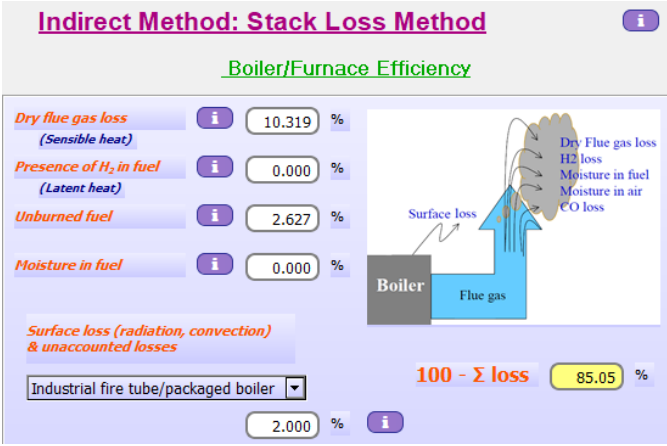

Energetic analysis interface by indirect method



Exergy analysis



Based on Second Principle, it provides information about **irreversibilities** generated in each device of the installation, including the internal of the combustion process.

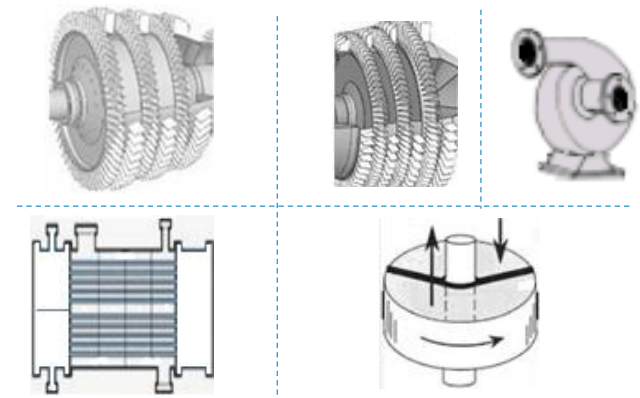

Devices

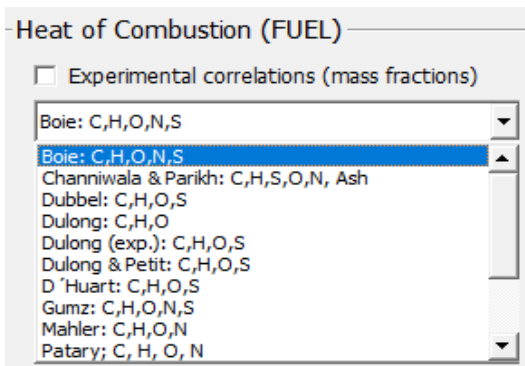

Heat of combustion of the fuel by means of experimental correlations

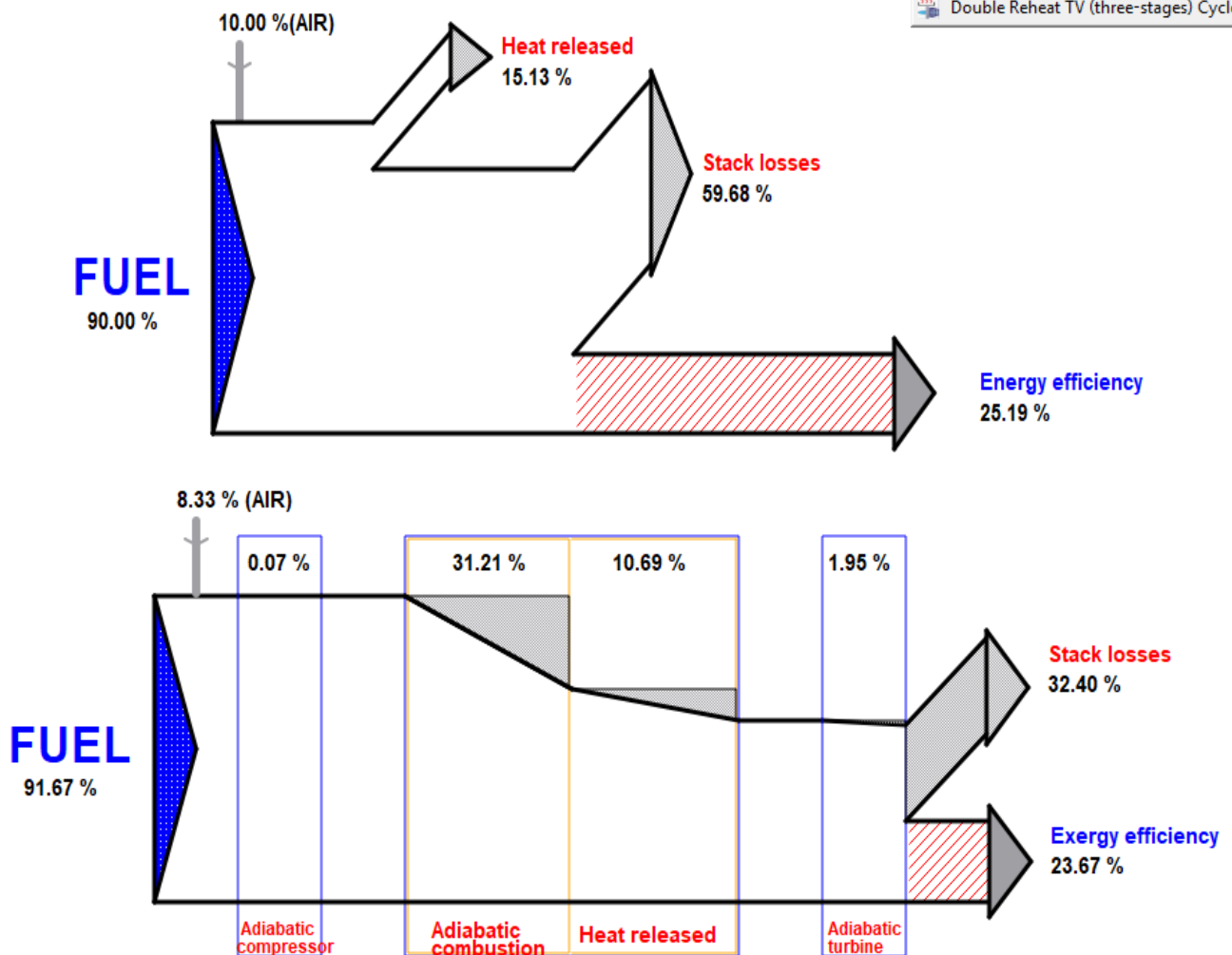
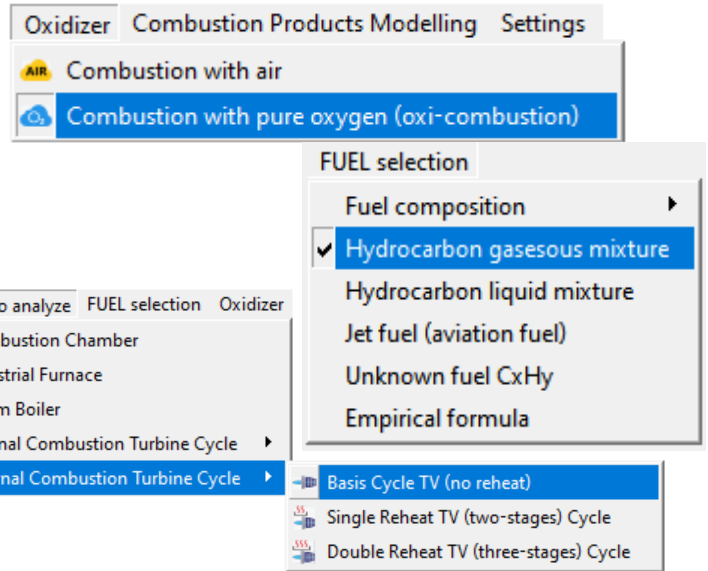

Results visualization using a Grassmann combustion diagram

In summary, **Thermocombustion** provides a complete solution of combustion processes; analysing the effect of the main variables that participate in the process, through the possibility of performing a graphical sensitivity analysis.

Whole range of software capabilities facilitates an improvement in combustion process design, an exhaustive study of main variables effects, and the possibility to reduce irreversibilities or pollutant emissions. A final report (set up by the user) can be submitted, containing graphs and predictions.

Major application for process optimization in **industry** or combustion processes study in **academia**.

Application specifications

This software's capabilities are appropriate for combustion studies in academia. The features explained above are highly useful; however, some additional ones should be taken into consideration. **Thermocombustion** include an **integrated database** with thermo-physic properties annotated from a wide range of chemical compounds. Moreover, a prediction of **thermodynamic properties** of combustion products and **equilibrium composition** can be obtained.

Thermodynamic state
 Liquid Gas

Cas number:

| | | |
|---|----------|-----------|
| Molecular Weight | 58.0791 | kg/kmol |
| Enthalpy of Formation | -218500 | kJ/kmol |
| Internal Energy of Formation | -212303 | kJ/kmol |
| Standard Gibbs Free Energy of Formation | -156.6 | kJ/mol |
| Helmholtz Free Energy of Formation | -150.403 | kJ/mol |
| Standard Entropy at 1atm | 295.3 | kJ/kmol K |
| Standard Chemical Exergy | 1798.44 | kJ/mol |

Thermodynamic properties annotated on software database for methane

An **integrated database** on software with more than 100 (for industrial version) chemical compounds with thermo-physic properties annotated. Available to **combine at least 25 compounds as an input mixture** to analyse.

CHEMICAL EQUILIBRIUM REACTIONS

Temperature (400°C < T < 5000°C)
 Adiabatic T^a 1700.0 °C Products T^a

kJ/mol fuel

Consider adiabatic process: T(products)=T(adiabatic)

| | Degree of dissociation | Equilibrium constant, K _p | ΔG | ΔH | ΔS |
|--|------------------------|--------------------------------------|----------|----------|-----------|
| | | | kJ/kmol | kJ/kmol | kJ/kmol K |
| CO ₂ ⇌ CO + 1/2 O ₂ | -2.101 | 0.00101717 | 113047.9 | 278028.9 | 83.6130 |
| H ₂ O ⇌ H ₂ + 1/2 O ₂ | 0.0093000 | 0.00023014 | 137428.1 | 237489.0 | 50.7112 |
| 1/2 O ₂ ⇌ O | 0.02061510 | 0.00052803 | 123804.0 | 255250.4 | 66.6175 |
| 1/2 H ₂ ⇌ H | 0.00143258 | 0.00132332 | 108731.2 | 226791.5 | 59.8334 |
| 1/2 N ₂ ⇌ N | 6.949e-08 | 5.851e-10 | 348773.2 | 480222.7 | 66.6191 |
| FORMATION OF NITROGEN OXIDES | | | | | |
| 1/2 N ₂ + 1/2 O ₂ ⇌ NO | 0.6271412 | 0.01843708 | 65514.7 | 90502.6 | 12.6640 |
| 1/2 N ₂ + O ₂ ⇌ NO ₂ | 0.0008651 | 0.00008880 | 153051.1 | 34700.8 | -59.9804 |
| NO + 1/2 N ₂ ⇌ N ₂ O | 0.0000318 | 0.00005837 | 159935.1 | -1296.9 | -81.7130 |

Composition analysis of combustion products on chemical equilibrium

Theoretical determination of the **equilibrium composition** and **thermodynamic properties** of combustion products, related to temperature and pressure, as well as the dosage used or the fuel gas mixture, according to chemical balance and dissociation.

